

Article number: 0105062
 Description: Retaining ring AV 45
 Note: Fitted with ZGA pliers

Measures

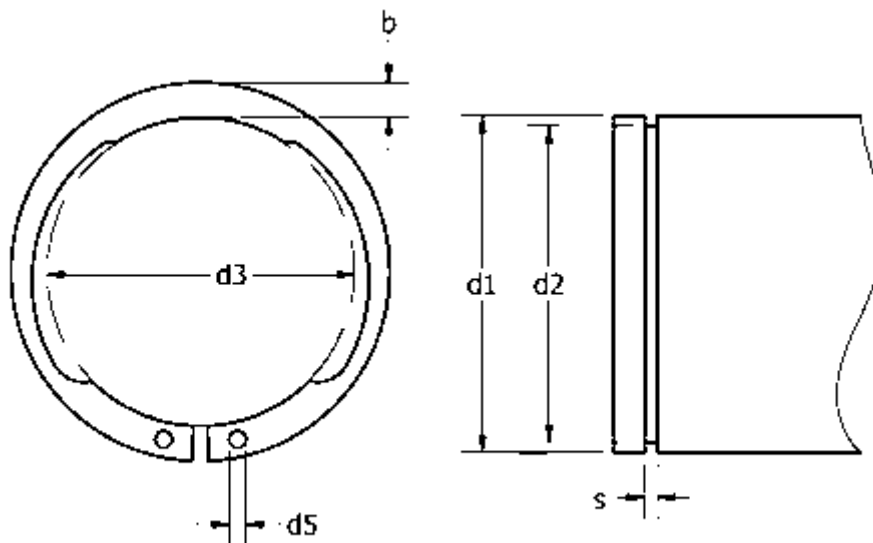

AN mm ²	= 86.0	FRg kN	= 7.8	t	= 1.25
b	= 4.7	FR kN	= 41.5	tol	= -0.06
d1	= 45	g	= 2.0	tol	= -0.25
d2	= 42.5	K kN-mm	= 75.0	tol	= +0,39-0,90
d3	= 41.50	m min	= 1.85	tol	= 0.2
d5 min	= 2.0	n abl x 1000	= 11	Tong	= ZGA-2
Description	= AV 45	s	= 1.75	Weight kg/1000	= 7.80
FN kN	= 14.30	Side power N at I2	= 3.8		